



SREDA
Software Solutions

True multi-hop data routing over BT LE

Product features and competitive differentiation

Yaroslav Domaratsky, PhD
CTO, Head of Engineering
Sreda Software Solutions

yaroslav@sredasolutions.com

Multi hop data routing versus data broadcasting for BT LE apps

Wireless Mesh Network (WMN) multi hop data routing algorithms classified as:

- Proactive (e.g. OLSR, RFC 3626)
 - Always maintain a current list of routes to each node in the network
- Reactive (e.g. AODV, RFC 3561)
 - Maintain no route information, but discover the most efficient route when a data packet is to be transmitted
- Hybrid routing algorithms (e.g. HWMP)
 - Use elements of both proactive and reactive routing.

Multi hop data routing algorithm developed by Sreda LLC for BT LE applications outperforms solutions based on broadcasting approach in the below areas:

- Data flooding overhead minimised
 - Data is not duplicated when transmitted
- Better utilization of radio resources
 - Data goes only through reliable radio links
- Better error handling
 - Radio link and node state (errors) constantly monitored and reported
- Better applications support
 - Network topology, node and link state (errors) information is available for the application level software
- Complex network topologies supported
 - Up to 7000 network nodes, up to 40 client devices for the each network node
 - up to 287 000 devices (network nodes and client devices) in the same BT LE network.

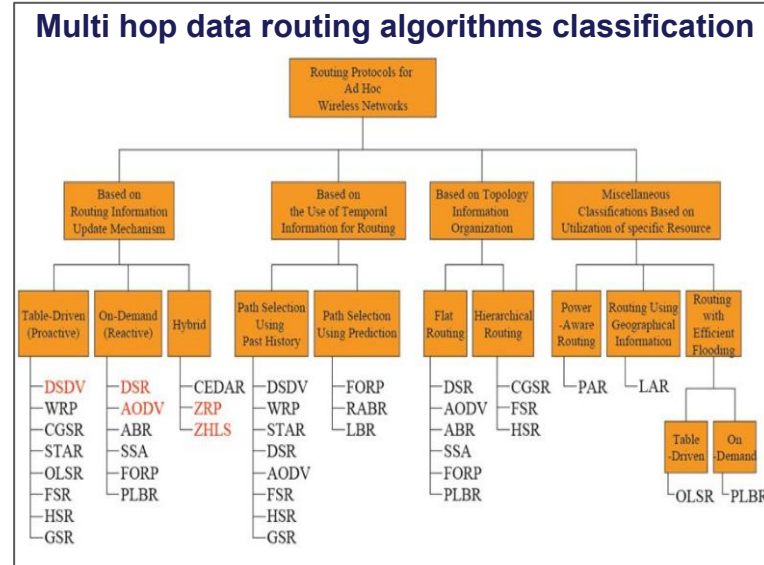
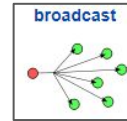
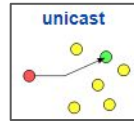

Information source: Mobile Broadband Communication Lab

Product information



OVERVIEW

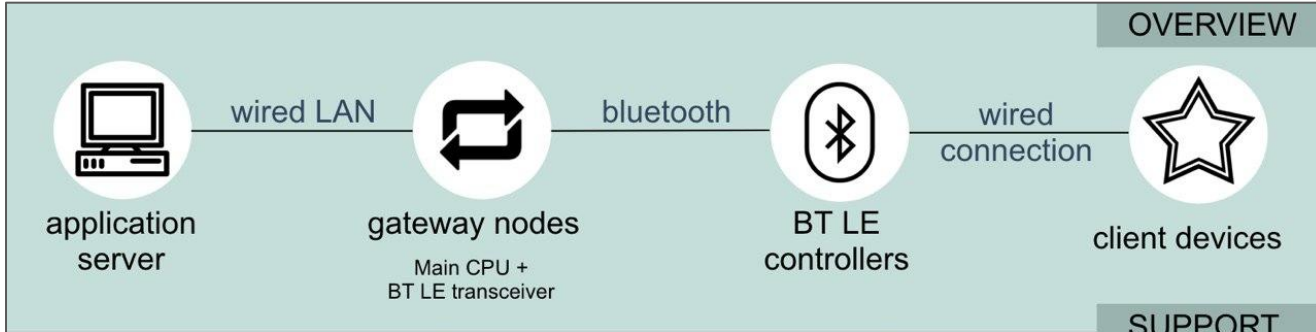

SUPPORT

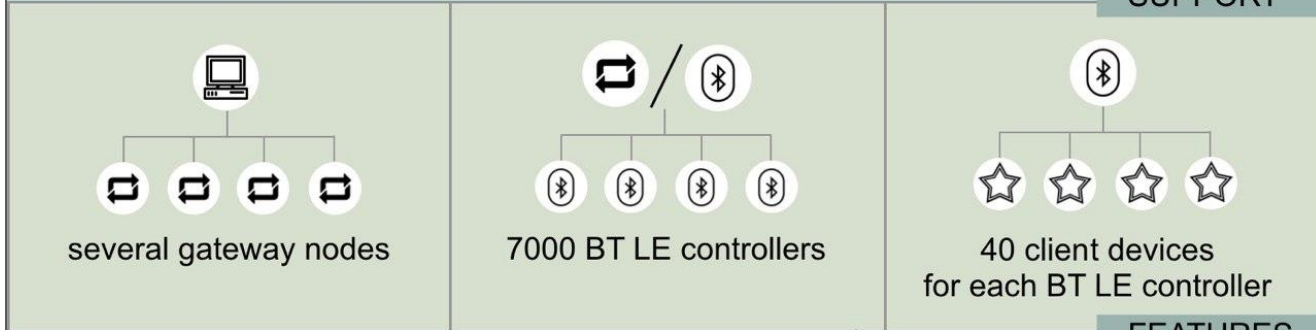

FEATURES

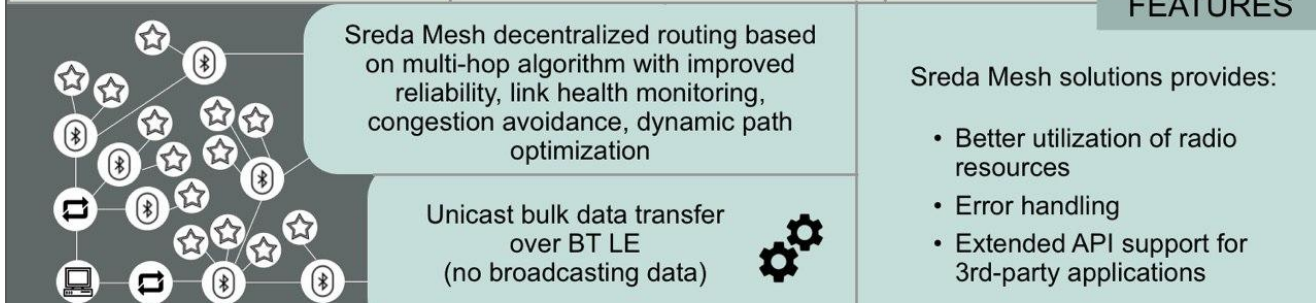

Sreda Mesh solutions provides:

- Better utilization of radio resources
- Error handling
- Extended API support for 3rd-party applications

Competitive differentiation

Feature	Sreda LLC product	BT SIG mesh (*)	Espressif ESP Mesh (*)
<u>Range extension</u> <i>Multi hop data exchange w/o central controller</i>	+	+	+
<u>Full scalability</u> <i>>= 7000 network nodes, >= 40 client devices for the each network node</i>	+	Vendor specific	87 network nodes 0 client devices
<u>Improved reliability</u> <i>Automatic detection of topology and environmental changes</i>	+	+	+
<u>Link health monitoring, congestion avoidance</u> <i>Automatic radio link state (errors) monitoring, automatic congestion avoidance</i>	+	-	-
<u>Dynamic data path optimization</u> <i>End-to-end data path quality monitoring, automatic alternative data path search</i>	+	-	-
<u>Bulk data transfer</u> <i>Transmit >=100 KBytes of data to a network node in a single operation</i>	+	-	+
<u>Applications development SDK</u> <i>Device management, software upgrades</i>	+	Vendor specific	+
<u>Small memory consumption</u> <i>Less than 32 KBytes RAM usage</i>	+	+	+
<u>Control and configuration over Internet</u> <i>Access over Internet to mesh network to control and configure nodes</i>	+	Vendor specific	+

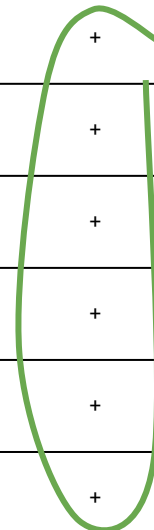

* - based on the publicly available information

Product timeline

- PoC demo (700 network nodes): available
- MVP (7000 network nodes): Q1 2018

Target platform

- BT LE
 - Nordic nRF52832
 - The solution could be ported to other BT LE platforms
- Gateway node and applications server
 - Most popular Linux distributions
 - Windows platform running Cygwin.

Product demo video: <https://drive.google.com/open?id=0BwdPgUifW3WfYk5fWG5VTGppN00>